

## SPECIFICATION

- Part No. : TG.09.0113
- Product Name : Penta-band GSM Hinged SMA Male Dipole
- Feature : Rotatable hinge design for optimal reception  
 Top quality housing with brass hinge and connector  
 Extended operation temperature range  
 RoHS Compliant



Version	Date	Page	Revision Description	Prepared	Approved
A	Jan 9 <sup>th</sup> 2007	All	New Product	TW Product Centre	Zita Lin
B	Jun 9 <sup>d</sup> 2009	All	Hinge modification	TW Product Centre	Zita Lin
C	July 6 <sup>th</sup> 2009	All	Data for different TG.09 mounting condition	TW Product Centre	Zita Lin



## I. Introduction

TG.09 Penta-band GSM Hinged R/A SMA antenna is a quality antenna with high level electrical performance. The unique hinge design let the user able to rotate the antenna to the best angle for an optimal GSM signal reception. With the environmental harden casing, this antenna is the ideal GSM antenna for vehicle tracking device.

## II. Specification

Communication System	Penta-band Cellular				
	AMPS	GSM	DCS	PCS	UMTS
Frequency (MHz)	824 ~ 896	880~960	1710~1880	1850~1990	1710~2170
Free Space Efficiency*	21%	24%	23%	32%	31%
Free Space Gain (dBi)*	2.0	2.0	-1.0	-0.4	-0.1
Efficiency of TG.09 mounted on PCB*	39%	31%	78%	75%	75%
Gain of TG.09 mounted on PCB*	1.0	-1.0	2.8	2.8	2.0
Impedance	50 Ohm				
Radiation Pattern	Omni-directional				
Polarization	Linear				
Power Rating	10W				
Connector	SMA male (brass)				
Operation Temperature	-40°C ~ +85°C				
Storage Temperature	-40°C ~ +105°C				

\* Average efficiency and peak gain of antenna sitting 180° in free space and mounted at the side of the PCB. Please refer to section IV for testing detail.



### III. Electrical Property – Return Loss

Return Loss measure the amount of signal energy that is reflected back to the system (the network analyzer) due to impedance mismatch between the 50ohm network analyzer and the antenna. -3dBi means half of the energy is reflected back and -10dBi means 10% of energy is reflected back to the system.



TG.09 Return Loss

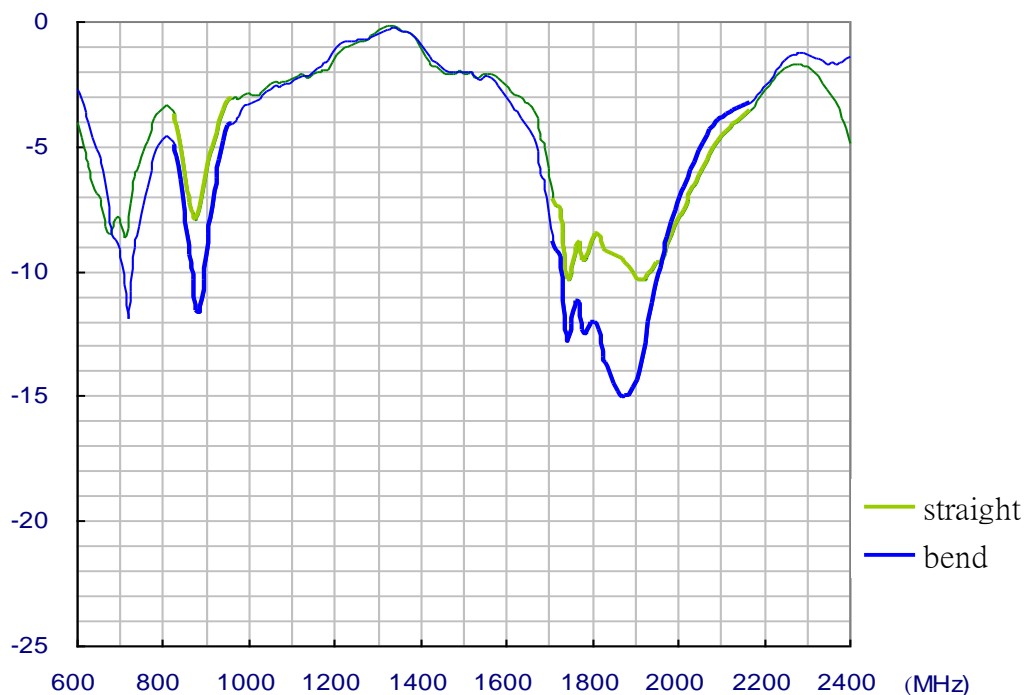

TG.09 tested by Agilent 8753ES



## IV. Electrical Property – Efficiency

Antenna normally behaves differently when mounting on a different environment. So we test the antenna in four different settings –

1. free space
2. on top of a 150 x 90mm ground plane. A common ground plane size for electronic device.
3. on the edge of a 150 x 90mm ground plane. Another common way of mounting antenna.
4. 450 x 350 ground plane. This simulates the situation of mounting TG.09 on top of a large metal object, such as a vehicle.

TG.09 can be installed in 5 different angles so we present the test in different combination of angles and mounting environment.

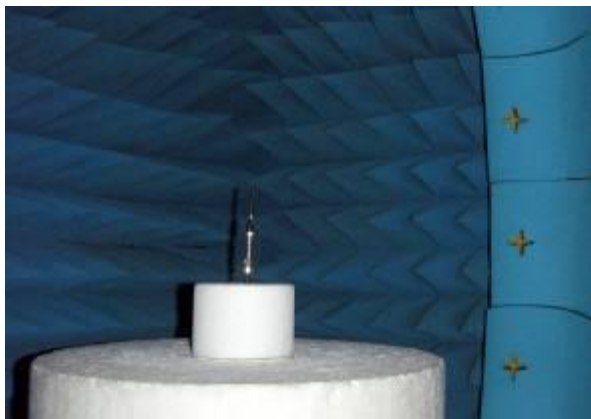

1. free space

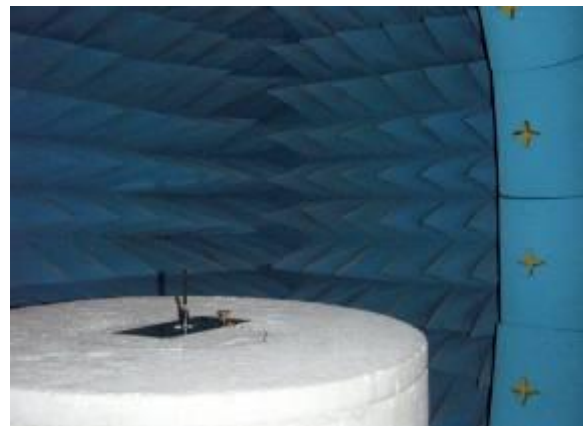

2. PCB size ground plane



Specification

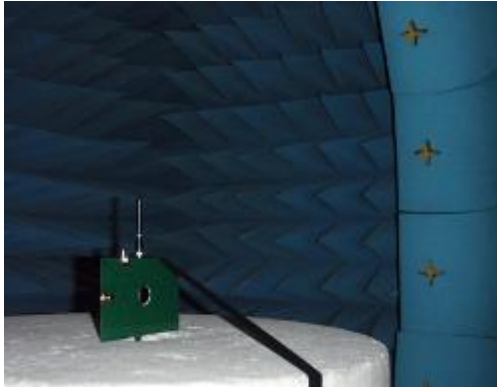

3. mounting upright



4. metal plane

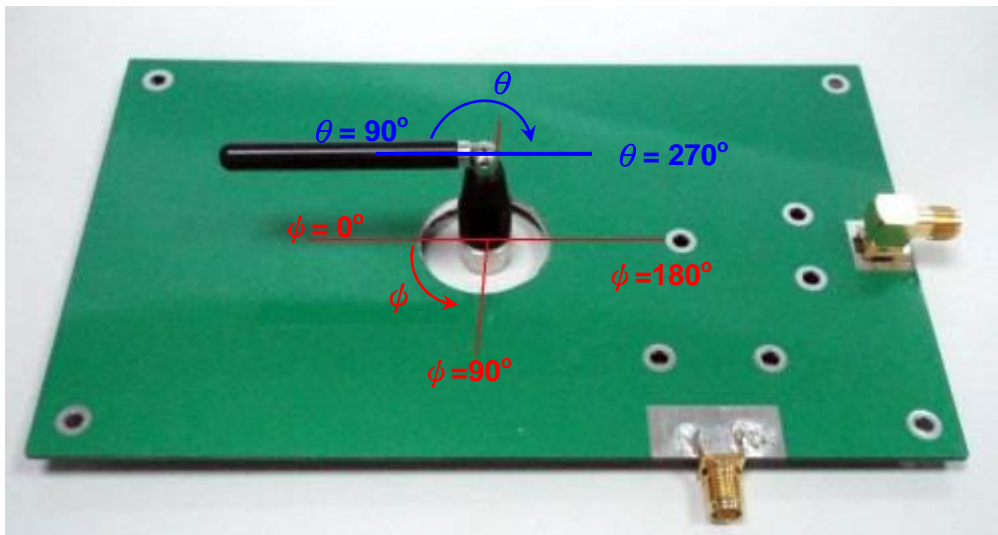

TG.09 on top of a 150x90mm PCB.  $\phi$  is the horizontal rotation and  $\theta$  is the vertical position of TG.09 with respect to the 3D chamber. In the Satimo chamber,  $\phi = 0$  is the x-axial,  $\phi = 90^\circ$  is the y-axial and  $\theta = 180^\circ$  is the z-axial.



### IV.1. TG.09 on Different Mounting Condition

Here we compare TG.09 in its most common installation angles (90° and 180°) with different mounting environments.

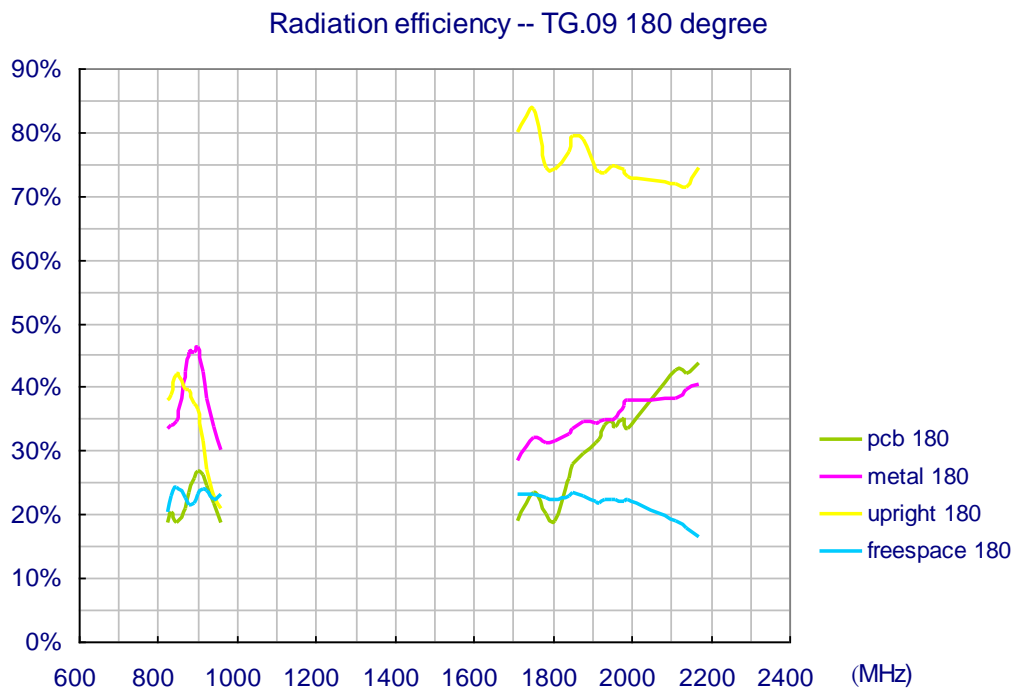

Antenna in straight position (180°) on different mounting condition.



Specification

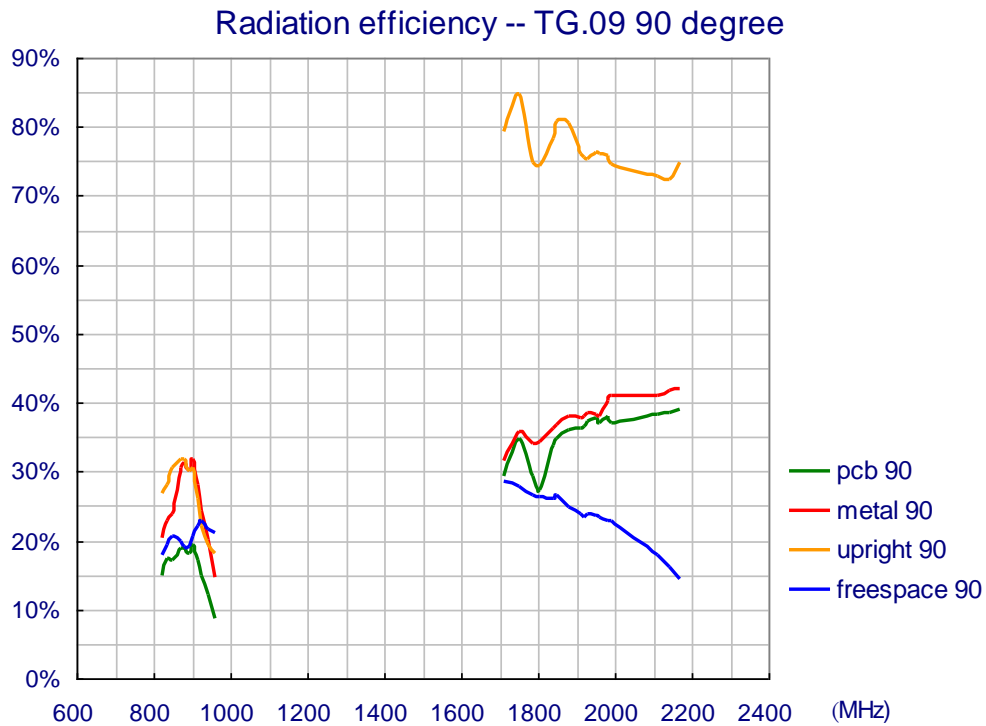

Antenna in right angle position (90°) on different mounting condition.

TG.09 is a monopole antenna. It works better with the present of a ground plane. The size of the ground plane does not affect the radiation efficiency much as long as it is greater than 1/4 wavelength (1/4 wavelength for 824MHz is 91mm).



Specification

### IV.2. TG.09 of Different Rotation Angle

TG.09 has 5 different locking  $\theta$  angle and is free to mount at any angle around  $\phi$ . Different position of antenna with respect to the ground has different antenna radiation. We tested TG.09 in three common situation of antenna mounting.

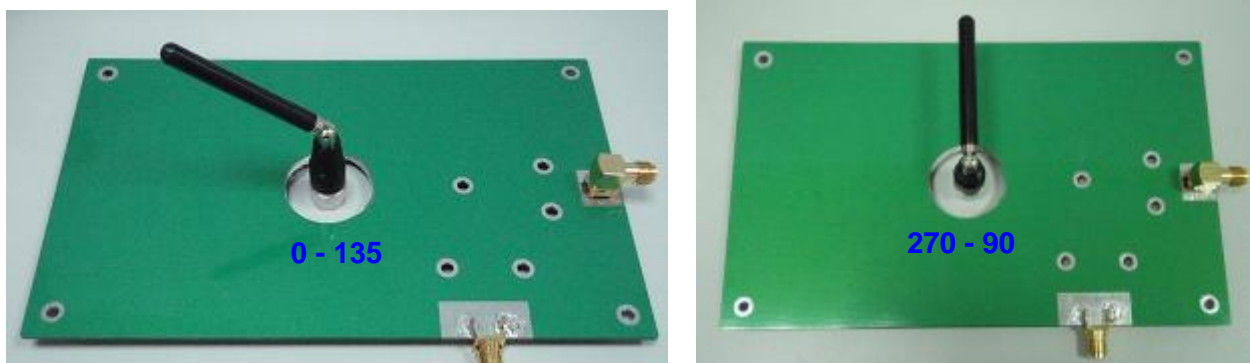

Different antenna mounting is marked as ( $\phi$  angle-- $\theta$  angel ), photos are two example of the position marking.

TG.09 mounted on PCB ground

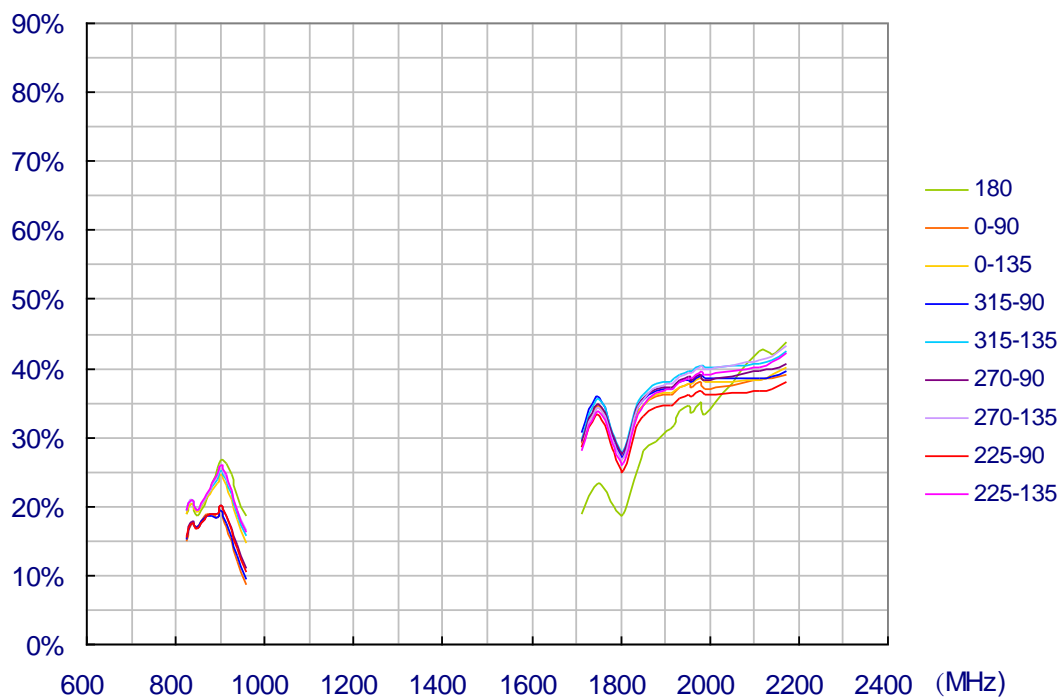





Specification

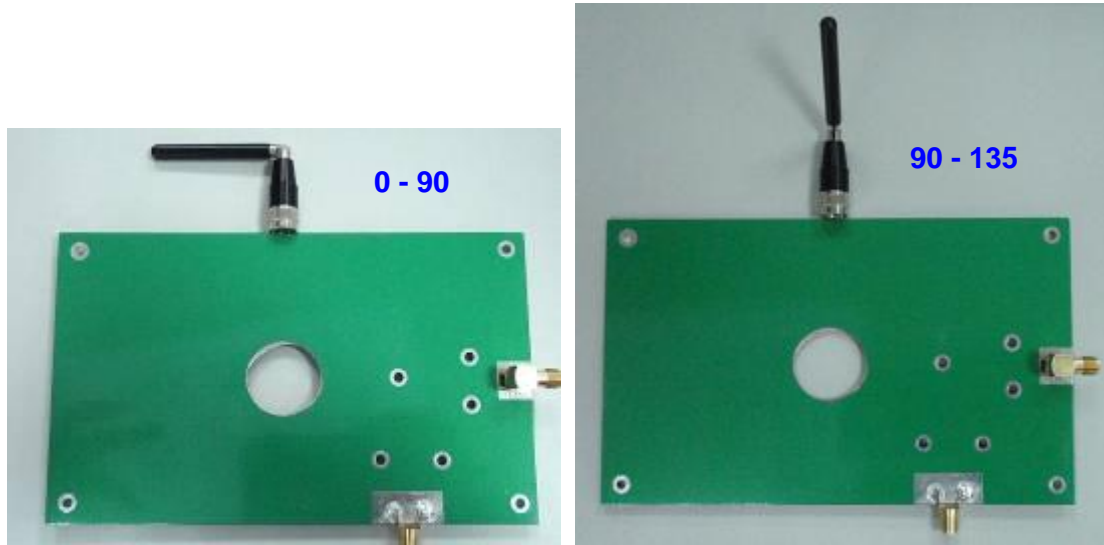

Example of upright mounting.

TG.09 mounted at the edge of PCB (upright position)

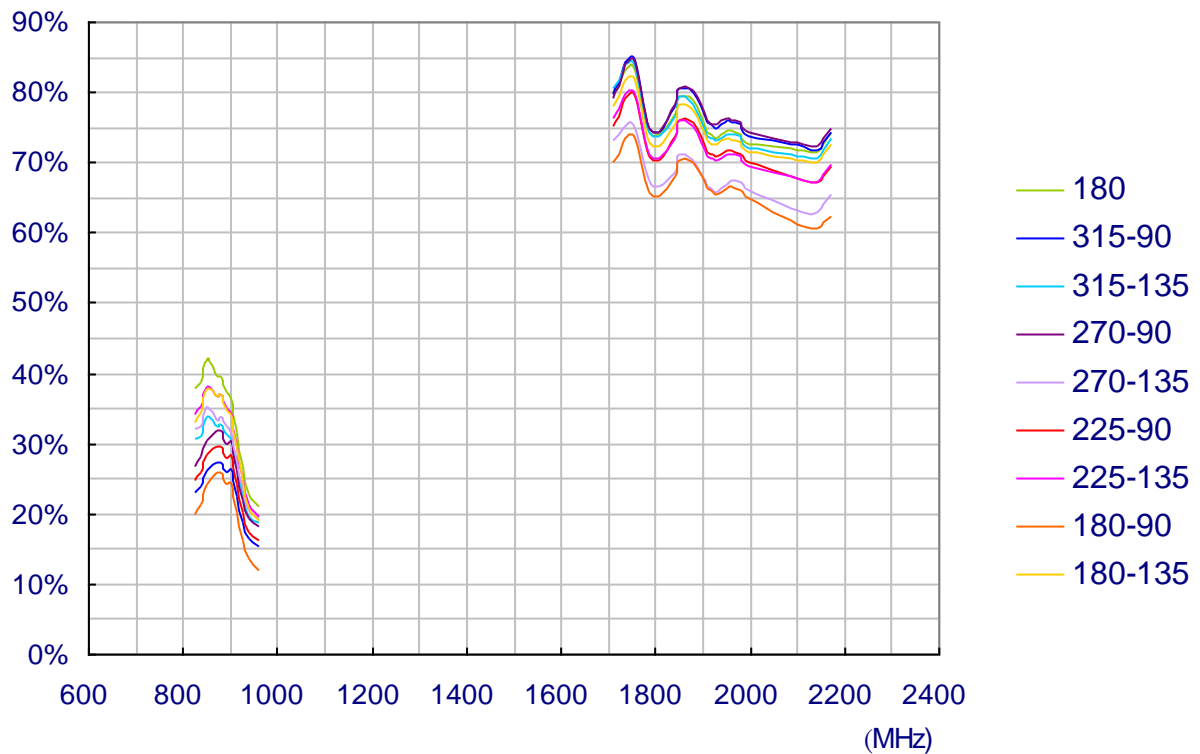



Specification

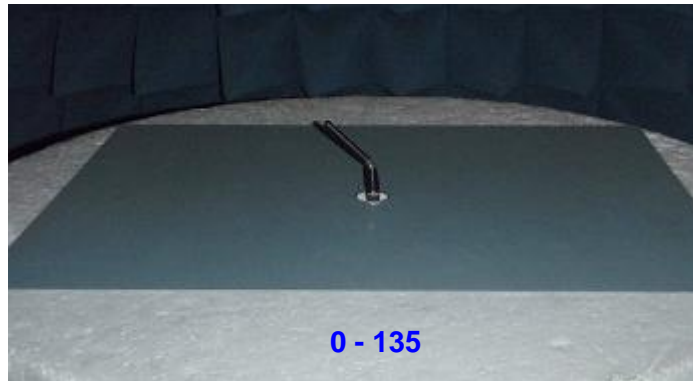

Example of TG.09 mounting on metal plane.

TG.09 mounted on metal plane



Different ground plane let TG.09 have very different efficiency distribution. Different TG.09 rotation for any given mounting ground has up to 20% efficiency different for each frequency, but has similar efficiency distribution.



## V. Radiation Pattern

### V.1. TG.09 in Free Space

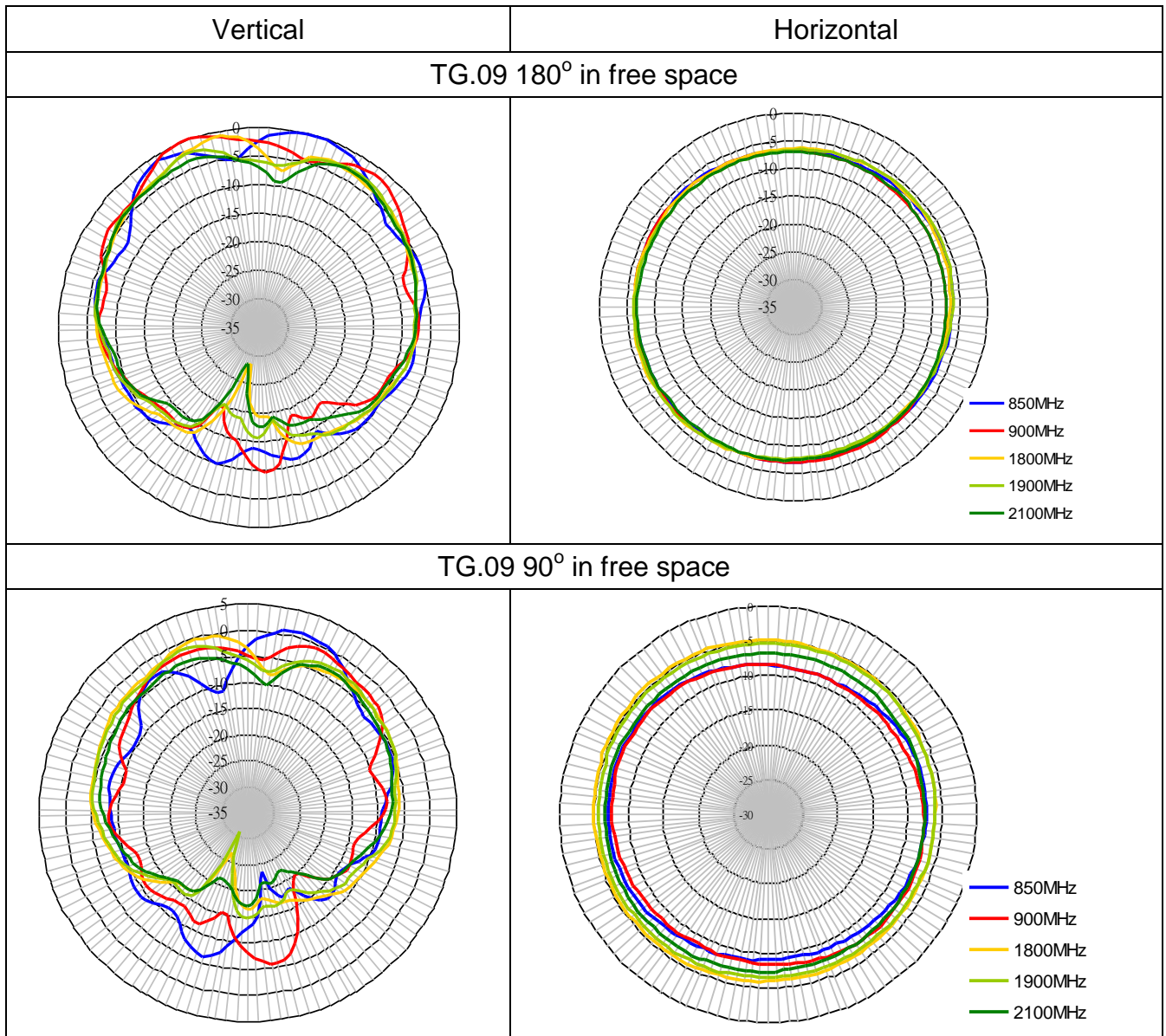

V.2. TG.09 Mounted on PCB

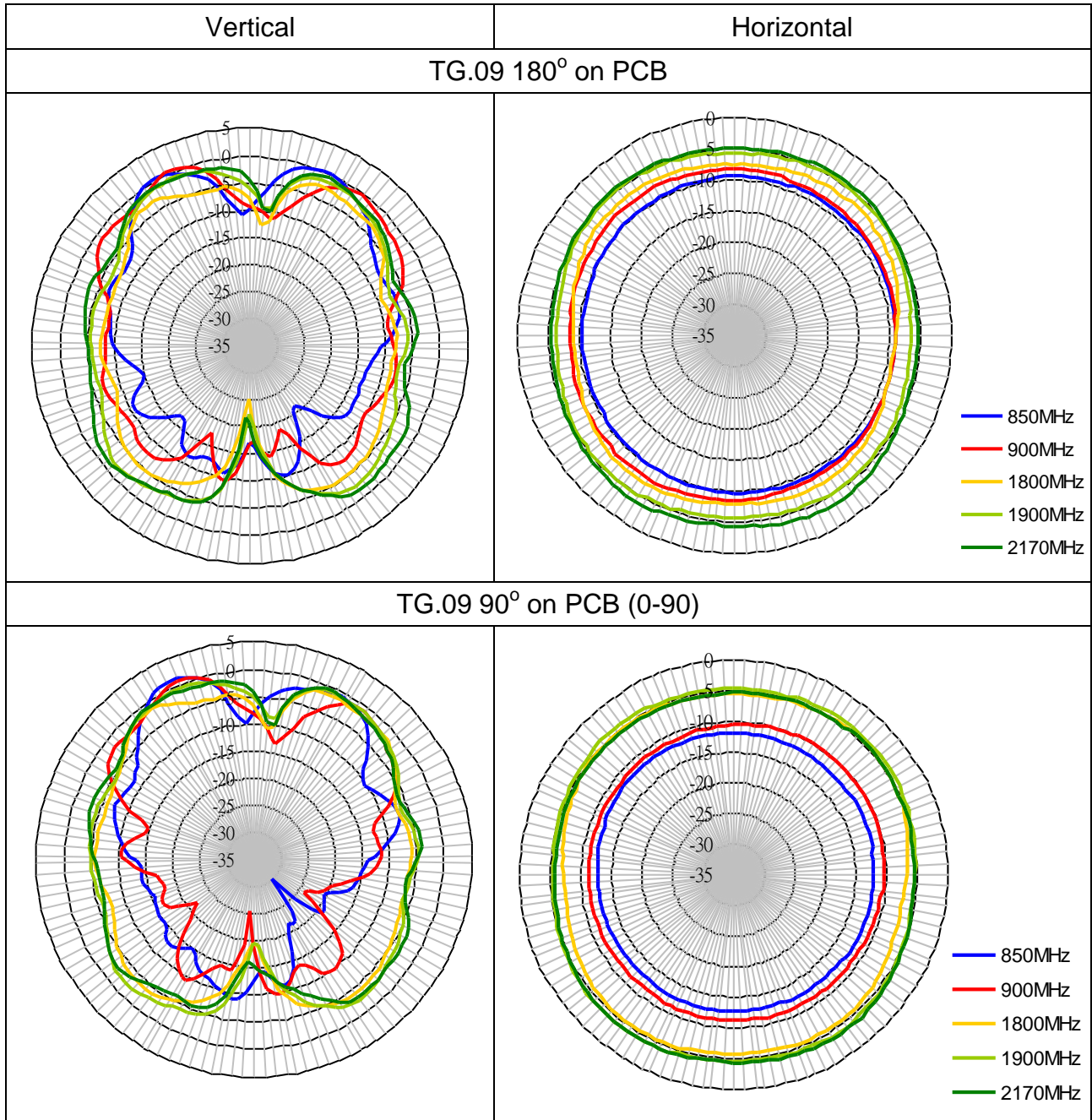





### V.3. TG.09 Mounted At a Side of PCB

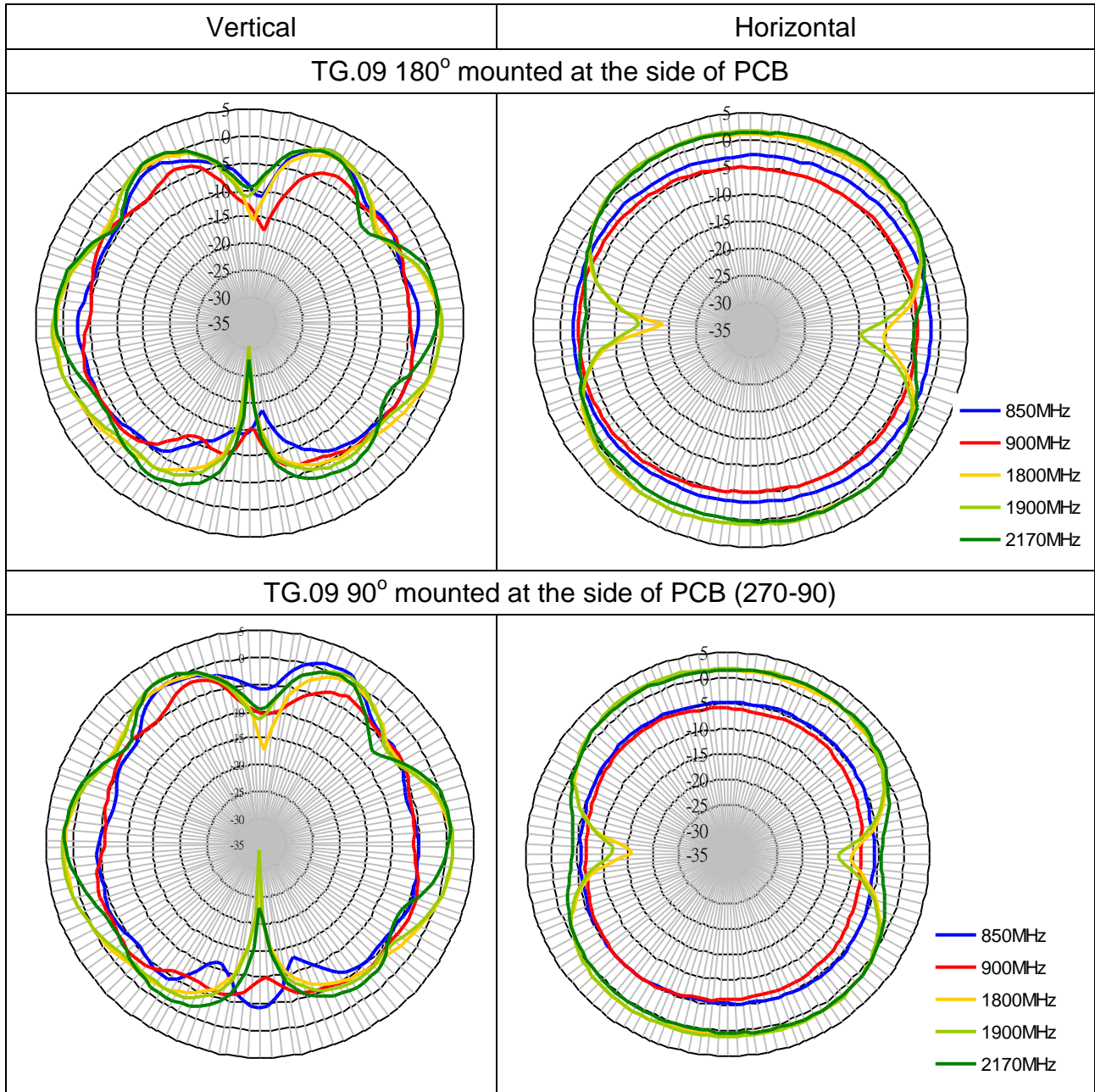



### V.4. TG.09 Mounted on a Metal Plane

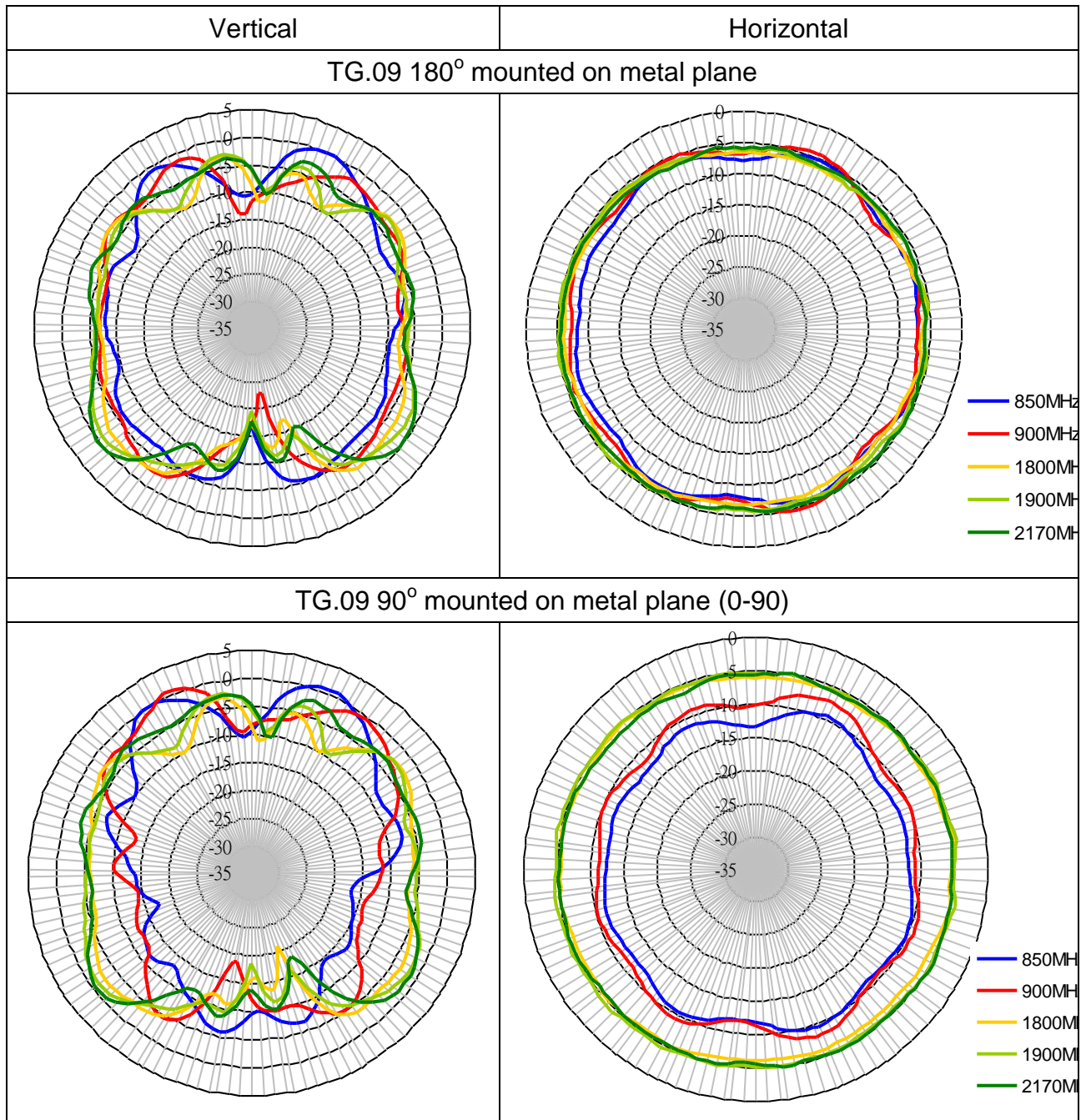



## VI. Mechanical Drawing

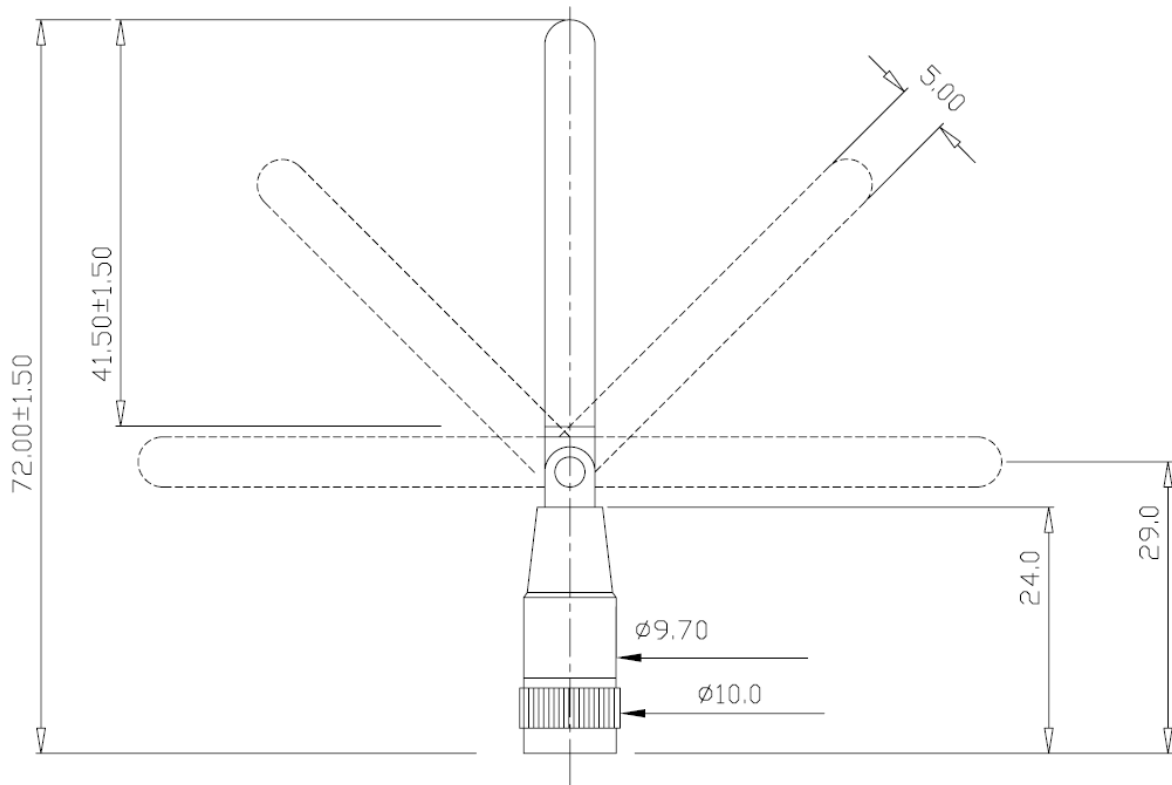

Unit : mm